



AIRCHARGER®

HIGH-FLOW INTAKE KITS

NOT LEGAL FOR SALE OR USE ON ANY POLLUTION CONTROLLED MOTOR VEHICLE IN CALIFORNIA OR STATES ADOPTING CALIFORNIA EMISSION PROCEDURES.
See knfilters.com for CARB status on each part for a specific vehicle

INSTALLATION INSTRUCTIONS

63-1560

DODGE

2008-09 Caliber SRT4

L4-2.4L Turbo

TOOLS NEEDED:

- 4mm Allen Wrench
- 7mm Socket
- 10mm Socket
- 13mm Socket
- 10mm Wrench
- 13mm Wrench
- 5/8" Wrench
- 7/16" Wrench
- Extension
- Flat Blade Screwdriver
- Pliers
- Ratchet

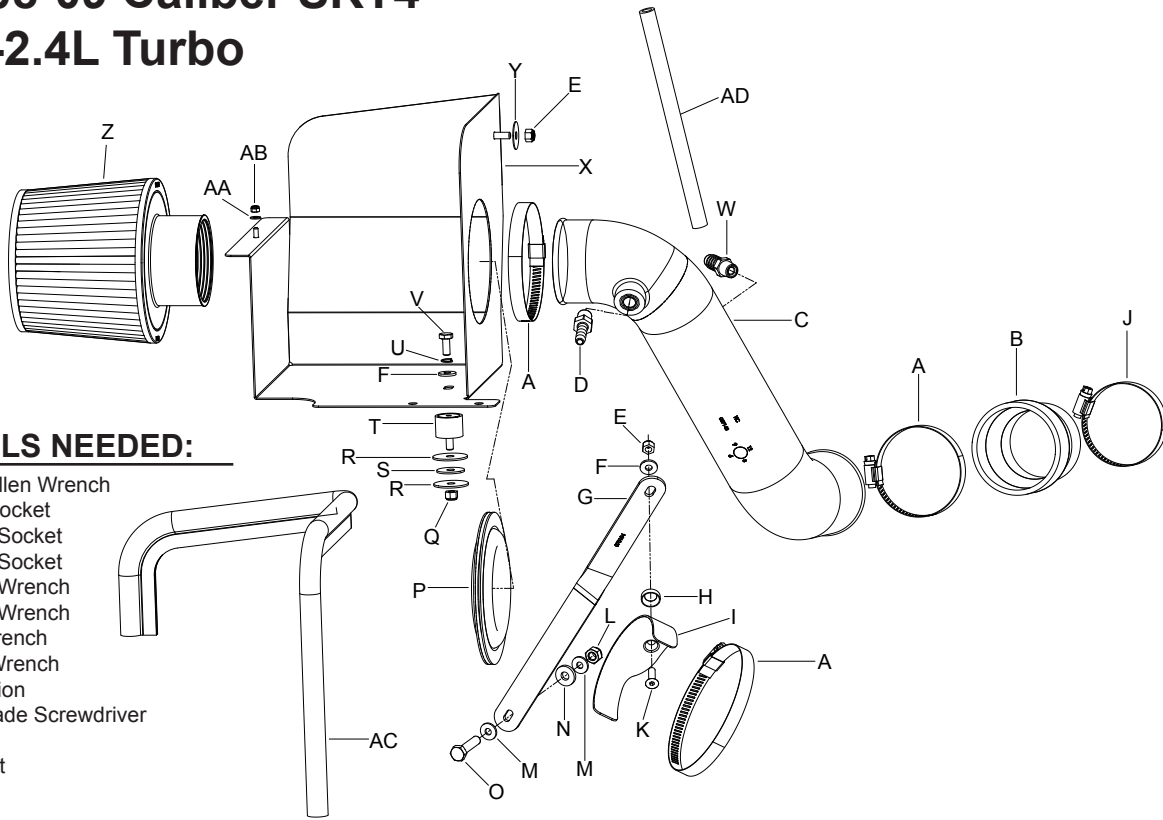

PARTS LIST:

Description	Qty.	Part #
A	3	08601
B	1	08095
C	1	087143
D	1	08908
E	2	07512
F	2	08275
G	1	070104
H	1	08180
I	1	078855
J	1	08554
K	1	08315
L	1	07519
M	2	08276
N	1	08129
O	1	07784
P	1	102469
Q	1	07502
R	2	08151
S	1	21685
T	1	070226
U	1	08198
V	1	08376
W	1	080022
X	1	074044
Y	1	08160
Z	1	RU-3570
AA	1	08278
AB	1	07501
AC	1	102489
AD	1	08402

NOTE: FAILURE TO FOLLOW INSTALLATION INSTRUCTIONS AND NOT USING THE PROVIDED HARDWARE MAY DAMAGE THE INTAKE TUBE, THROTTLE BODY AND ENGINE.

TO START:

1. Turn off the ignition and disconnect the negative battery cable.
NOTE: Disconnecting the negative battery cable erases pre-programmed electronic memories. Write down all memory settings before disconnecting the negative battery cable. Some radios will require an anti-theft code to be entered after the battery is reconnected. The anti-theft code is typically supplied with your owner's manual. In the event your vehicles' anti-theft code cannot be recovered, contact an authorized dealership to obtain your vehicles anti-theft code.

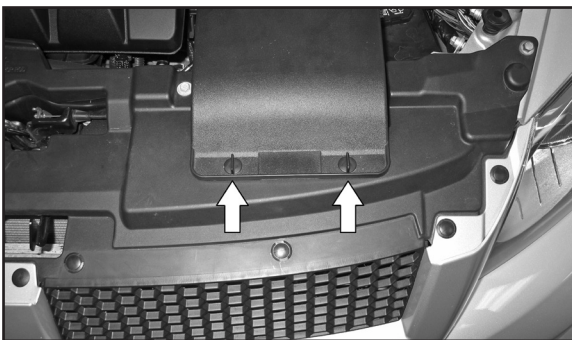

2. Unlock the two fresh air retaining clips by turning a ¼ turn counter clockwise.



3. Remove the fresh air intake scoop from the vehicle.

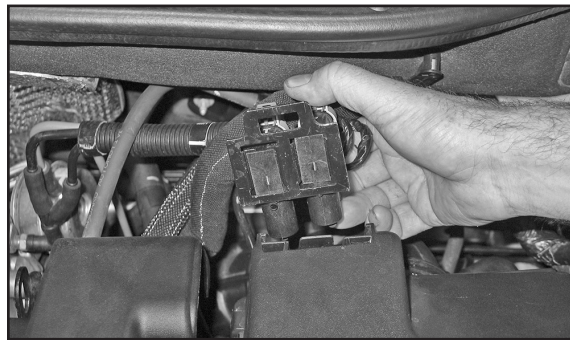

4. Release the clip which holds the vacuum switches to the upper air box and then unhook the vacuum switches from the air box.



5. Unhook the upper air box retaining clips and then remove the upper air box as shown.



6. Loosen the two hose clamps that secure the intercooler transition tube. Then remove the intercooler transition tube.



7. Lift up the engine cover to dislodge it from the mounting studs and then remove the engine cover from the vehicle.



8. Release the spring clamp that secures the crank case breather hose to the valve cover. Then disconnect the crank case breather hose.

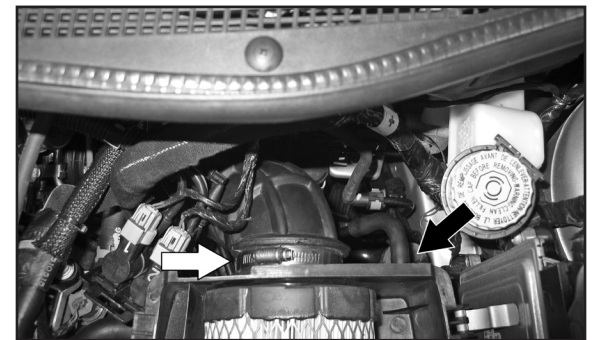

9. Loosen the hose clamp that secures the factory intake hose to the air box. Then unhook both the intake hose and vent hose from the air box.

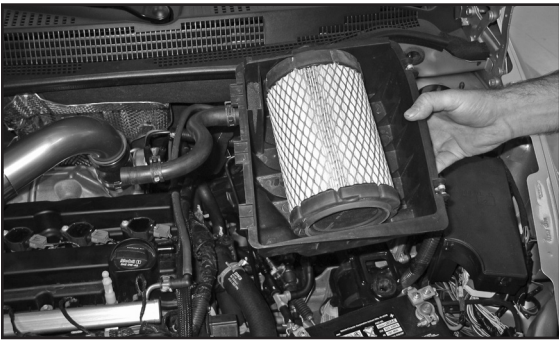

10. Lift up the air box to dislodge it from the mounting grommets. Then remove the air box from the vehicle.

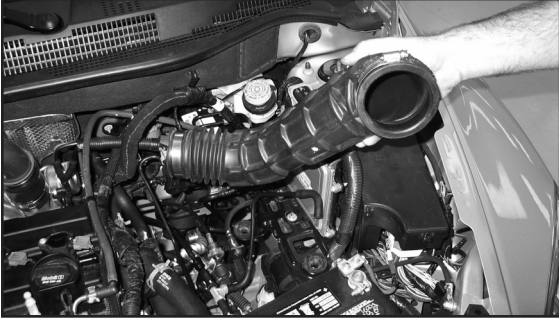

11. Loosen the hose clamp that secures the intake hose to the turbo inlet and then remove the intake tube from the vehicle.
NOTE: K&N Engineering, Inc., recommends that customers do not discard factory air intake.



12. Remove the center air box mounting grommet shown.



13. Install the rubber mounted stud into the center air box mounting location as shown. **NOTE: Be sure to use the two fender washers on either side of the mounting bracket and the rubber washer between the fender washers.**



14. Remove the two ECU mounting nuts shown. **NOTE: These nuts will be reused in a later step.**

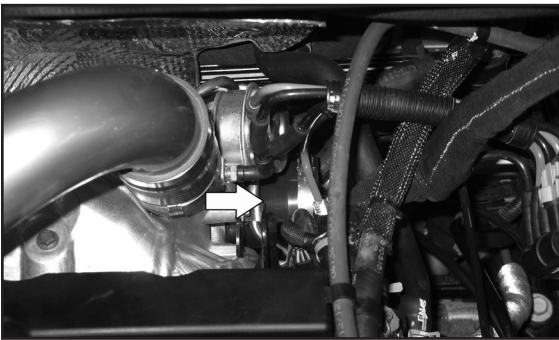

15. Install the provided silicone hose (08095) onto the turbo inlet and secure it with the provided hose clamp.

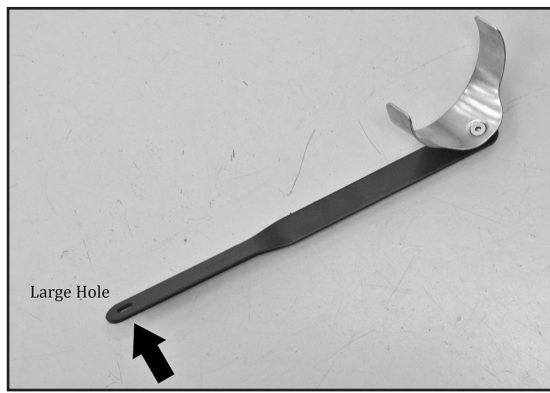

16. Secure the saddle clamp to the mounting bracket (070104) as shown.

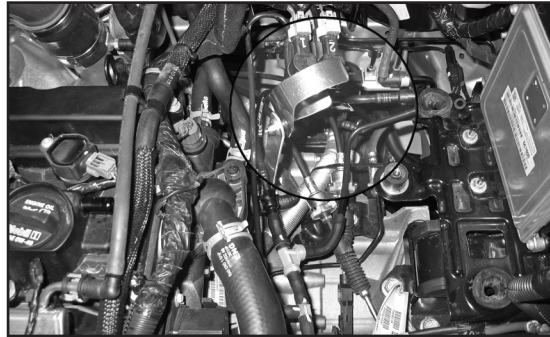

17. Secure the intake tube mounting bracket to the driver's side of the tab on the transmission using the provided hardware.

NOTE: Be sure to place the provided thick washer between the mounting tab and bracket as a spacer. The mounting tab is on the bell housing next to the transmission mount, below the shift linkage and cooling hoses.

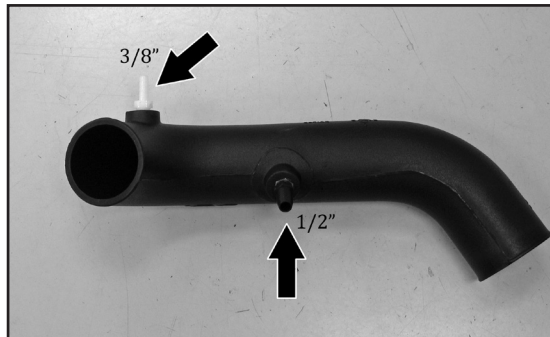

18. Install the two 1/4NPT fittings into the K&N® intake tube as shown.

NOTE: Plastic NPT fittings are easy to cross thread. Install the vent fitting "hand" tight, then turn it two complete turns with a wrench.

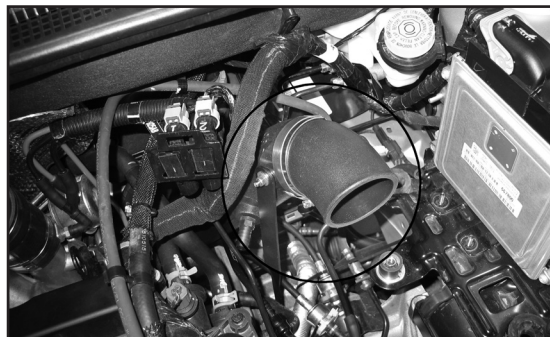

19. Install the K&N® intake tube into the silicone hose at the turbo inlet and align with the mounting bracket, then secure with the provided hose clamps.



20. Install the provided crank case vent hose to the 1/4NPT X 1/2" on the K&N® intake tube and then attach the other end to the vent port on the valve cover as shown.



21. Attach the remaining vent hose to the 1/4NPT X 3/8" vent fitting installed in the K&N® intake tube.

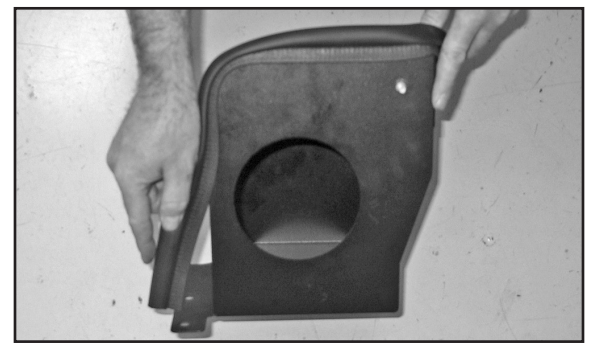

22. Install the provided edge trim onto the heat shield as shown.
NOTE: Some trimming of the edge trim will be necessary.



23. Install the provided edge trim into the hole of the heat shield as shown.
NOTE: Some trimming of the edge trim will be necessary.



24. Install the heat shield onto the rubber mounted stud installed during step #13 and onto the ECU mounting studs. Then secure the heat shield with the factory ECU mounting bolts and hardware provided.

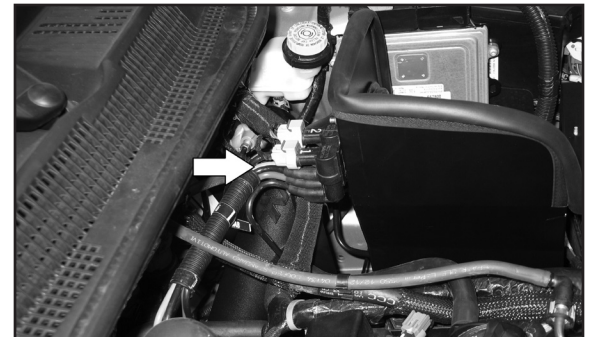

25. Secure the vacuum solenoids to the stud on the back of the heat shield using the provided hardware.



26. Reinstall the engine cover onto the valve cover.



27. Reinstall the intercooler tube and secure with the factory hose clamps.

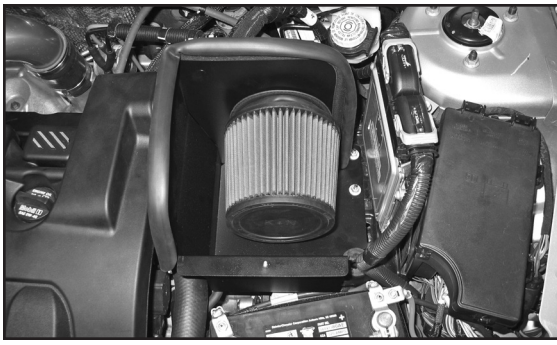

28. Install the K&N® air filter onto the intake tube and secure with the provided hose clamp.

NOTE: Drycharger® air filter wrap; part # RX-4990DK is available to purchase separately. To learn more about Drycharger® filter wraps or look up color availability please visit <http://www.knfilters.com>®.

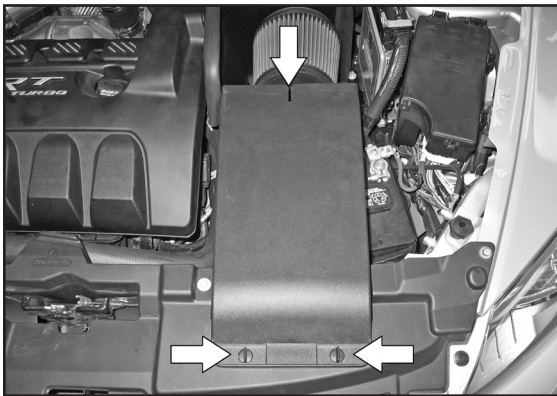

29. Install the fresh air intake duct onto the core support and heat shield, and then secure with the factory 1/4 turn clips and hardware provided.

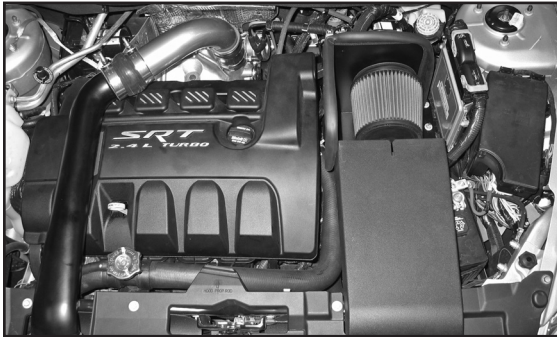

30. Reconnect the vehicle's negative battery cable. Double check to make sure everything is tight and properly positioned before starting the vehicle.

31. It will be necessary for all K&N® intake kits to be checked periodically for realignment, clearance and tightening of all connections. Failure to follow the above instructions or proper maintenance may void warranty.

ROAD TESTING:

1. Start the engine with the transmission in neutral or park, and the parking brake engaged. Listen for air leaks or odd noises. For air leaks secure hoses and connections. For odd noises, find cause and repair before proceeding. This kit will function identically to the factory system except for being louder and much more responsive.
2. Test drive the vehicle. Listen for odd noises or rattles and fix as necessary.
3. If road test is fine, you can now enjoy the added power and performance from your kit.
4. K&N Engineering, Inc., suggests checking the air filter element periodically for excessive dirt build-up. When the element becomes covered in dirt (or once a year), service it according to the instructions on the Recharger® service kit, part number 99-5050 or 99-5000.

NOT LEGAL FOR SALE OR USE ON ANY POLLUTION CONTROLLED MOTOR VEHICLE IN CALIFORNIA OR STATES ADOPTING CALIFORNIA EMISSION PROCEDURES.

See knfilters.com for CARB status on each part for a specific vehicle