

Installation Instructions

I - Sheet Number W01 Rev.A



Ventvisor® Deflector

**For proper installation and best possible fit, please read all instructions BEFORE you begin.
For technical assistance or to obtain missing parts, please call Customer Relations at 1-800-241-7219.**

Important Safety Information



- CAUTION - Before driving, ensure that the deflector vent is properly secured to vehicle.
- Do not use automatic "brush-style" car washes.
- Do not use cleaning solvents of any kind.
- Periodically check all components for tightness.

Contents - 2 Piece Set



Front Driver
Side Visor



Front Passenger
Side Visor



Alcohol
Pad x2

Contents - 4 Piece Set



Front Driver
Side Visor



Front Passenger
Side Visor



Rear Driver
Side Visor



Rear Passenger
Side Visor



Alcohol
Pad x4

Tools Required



Car Wash Supplies



Clean Towel

Preparation Before Painting / Installation

- A trial fit is recommended to ensure proper positioning and fit.
- Check fit of parts before painting as we will not accept the return of modified or painted parts.
- Wash your vehicle to remove any debris and/or dirt from installation area.
- Dry the installation area with a clean towel.

Installation Steps

NOTE: Actual application may vary slightly from drawings.



Clean the door's trim & mirror cap visor will attach.

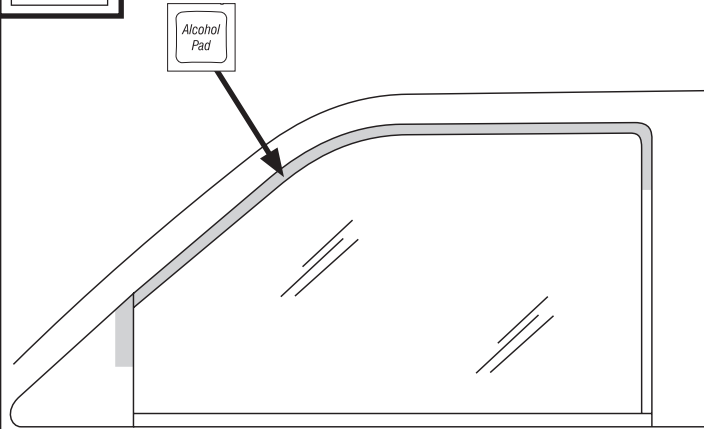

1

Remove the tape liner from the front & rear flanges. Peel back 2" of tape liner from each end of top flange.

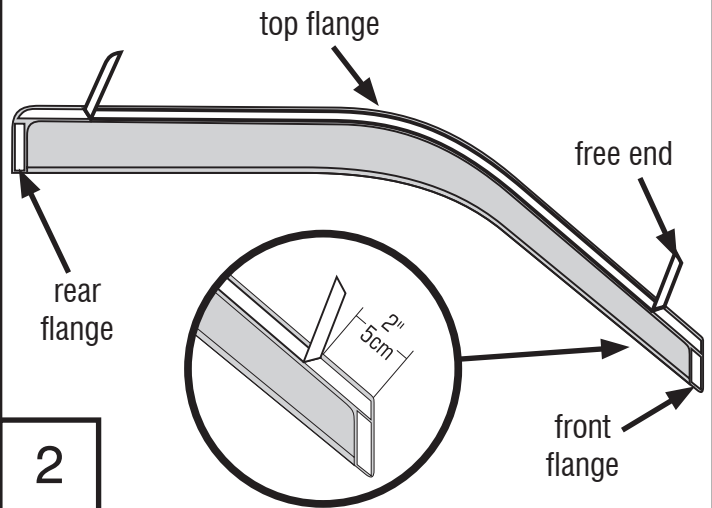

2

Attach the front flange to the mirror cap. Attach the top and rear flanges to the door's window trim. Remove tape liner by pulling on free ends.

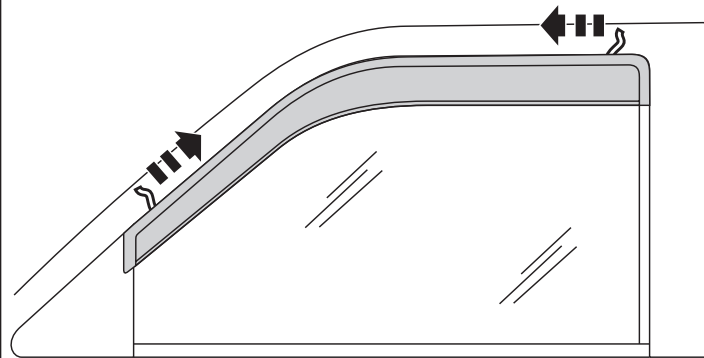

3

Apply pressure to the tape flanges to secure.

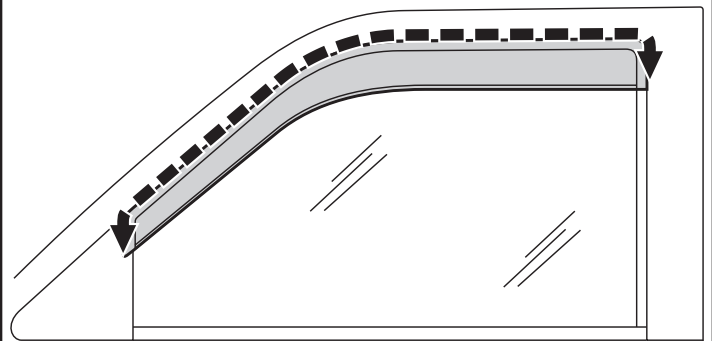

4

4 Piece Set

The rear visor attaches with same preparation methods as the front visor. Attach visor to the vehicle's window trim.

rear visor attached to trim

vertical window post

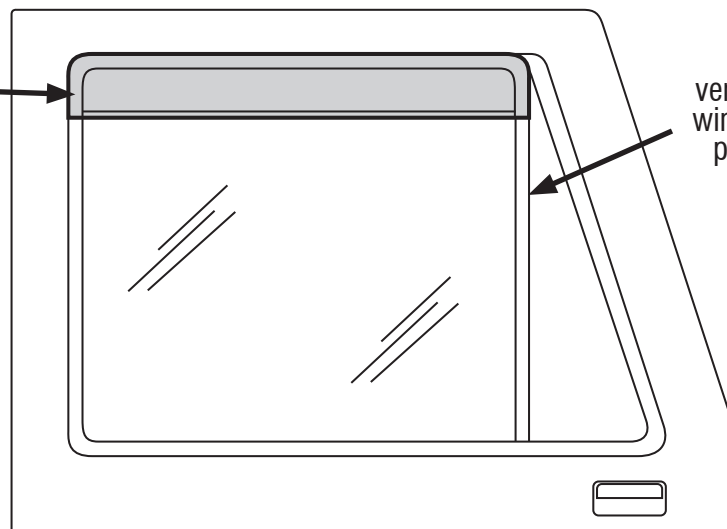

5

Care and Cleaning

- Wash only with mild soap & dry with a clean cloth.

Congratulations!

You have purchased one of the many quality Auto Ventshade™ branded products offered by Lund International, Inc. We take the utmost pride in our products and want you to enjoy years of satisfaction from your investment. We have made every effort to ensure that your product is top quality in terms of fit, durability, finish and ease of installation.



AUTO VENTSHADE™

Lund International, Ventshade Accessories Division

655 Raco Drive, Lawrenceville, GA 30045

800-241-7219 • Fax 770-339-5839 • Visit us at lundinternational.com



© 2005 Lund International, Inc. All rights reserved.

Auto Ventshade™, the Auto Ventshade™ logo and the AVS™ logo are trademarks of Lund International, Inc.





Défecteur Ventvisor®

Pour obtenir une installation correcte et le meilleur ajustement possible, lire toutes les instructions AVANT de commencer.
Pour toute assistance technique ou obtention de pièces manquantes, appeler le service des relations avec la clientèle au 1-800-241-7219.

Informations importantes concernant la sécurité



- **ATTENTION** – Avant de conduire, s'assurer que la visière est solidement assujettie sur le véhicule.
- Ne pas utiliser les stations de lavage de voitures à brosses.
- Ne pas utiliser de solvants.
- Vérifier régulièrement le serrage des composants.

Contenu - Ensemble 2 pièces **NOTE:** Le produit réel peut changer de l'illustration.



Visière avant
côté conducteur

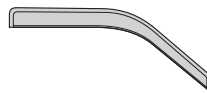

Visière avant
côté passager



Tampons à
l'alcool (2)

Contenu - Ensemble 4 pièces

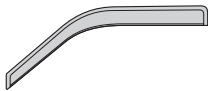

Visière avant
côté conducteur

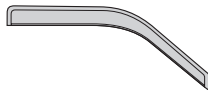

Visière avant
côté passager



Visière arrière
côté conducteur



Visière arrière
côté passager



Tampons à
l'alcool (4)

Outils nécessaires



Fournitures pour
lavage de voiture



Serviette propre

Préparation pour la peinture/l'installation

- Il est recommandé de procéder à un essai pour s'assurer que le positionnement et l'ajustement sont corrects.
- Vérifier l'ajustement des pièces avant peinture, car nous n'acceptons pas le retour de pièces modifiées ou peintes.
- Laver les glissières de glaces de la portière du véhicule pour éliminer toute poussière et tous débris.
- Sécher les glissières avec une serviette propre.

Étapes d'installation

REMARQUE : La méthode d'application peut être légèrement différente de celle représentée par les illustrations.



Nettoyer la garniture de la portière et le couvercle du rétroviseur, là où la visière doit être installée.

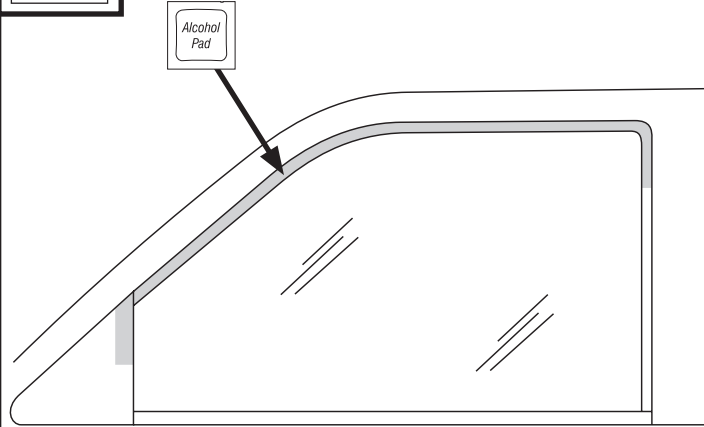

1

Retirer la protection d'adhésif des rebords avant et arrière. Décoller environ 5 cm (2 po) de protection d'adhésif à chaque extrémité du rebord supérieur.

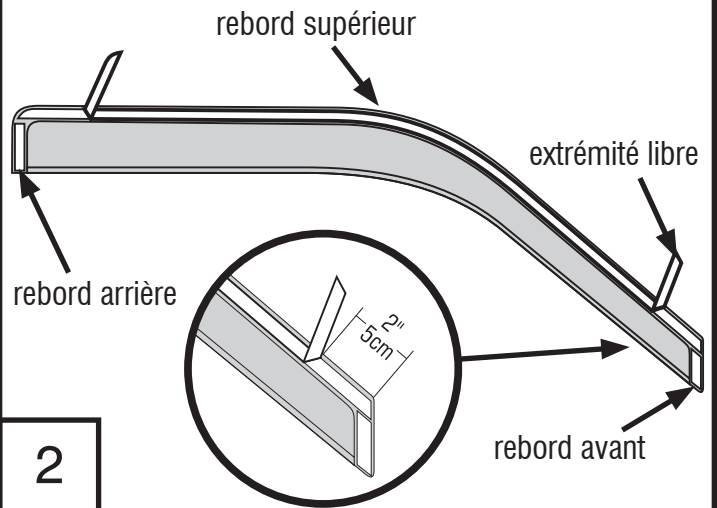

2

Fixer le rebord avant sur le couvercle du rétroviseur. Fixer les rebords supérieur et arrière sur la garniture de la glace de la portière. Retirer la protection d'adhésif en tirant sur les extrémités libres.

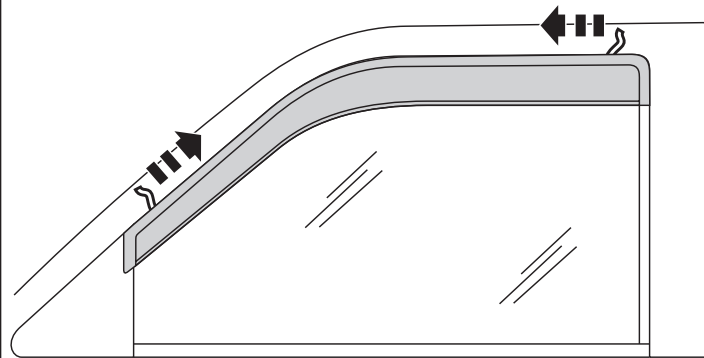

3

Appuyer sur les rebords du ruban adhésif pour bien faire adhérer ce dernier.

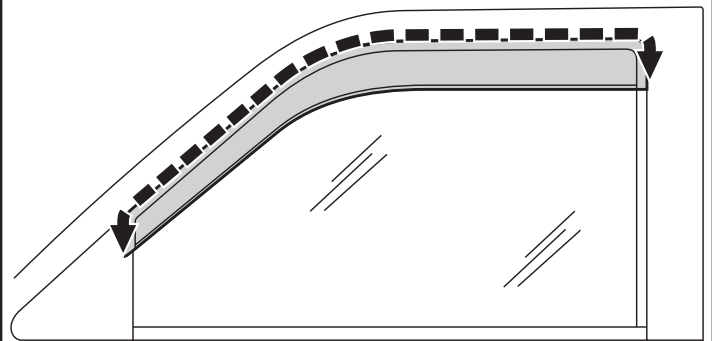

4

Ensemble 4 pièces

L'installation de la visière arrière demande la même préparation que la visière avant. Installer la visière sur la garniture de la glace du véhicule.

visière arrière fixée sur la garniture

montant vertical de la glace

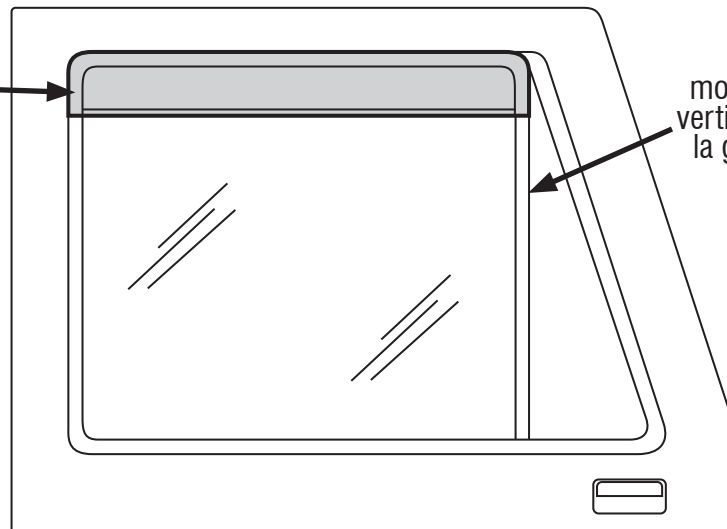

5

Entretien et nettoyage

- Laver exclusivement avec de l'eau savonneuse et sécher avec un chiffon propre.

Félicitations !

Vous avez acheté l'un des nombreux produits de qualité Auto Ventshade™ fabriqués par Lund International, Inc. Nous sommes extrêmement fiers de nos produits et souhaitons que vous tiriez des années de satisfaction de votre investissement. Nous avons pris toutes les mesures nécessaires pour assurer que ce produit est d'une qualité supérieure en ce qui concerne l'ajustement, la durabilité, la finition et la facilité d'installation.



AUTO VENTSHADE™

Lund International, Ventshade Accessories Division

655 Raco Drive, Lawrenceville, GA 30045, USA

800-241-7219 • Fax 770-339-5839 • Visitez notre site lundinternational.com



© 2005 Lund International, Inc. Tous droits réservés.

Auto Ventshade™, le logo Auto Ventshade™ et le logo AVS™ sont des marques déposées de Lund International, Inc.





Deflector Ventvisor®

Para una instalación adecuada y el mejor ajuste posible, lea todas las instrucciones ANTES de comenzar. Si desea recibir asistencia técnica u obtener piezas faltantes, llame al Servicio al cliente al 1-800-241-7219.

Información importante de seguridad



- PRECAUCIÓN - Antes de conducir, asegúrese de que la visera deflectora esté correctamente anclada al vehículo.
- No utilice servicios automáticos de limpieza de vehículos que utilizan cepillos.
- No utilice limpiadores al solvente de ningún tipo.
- Compruebe periódicamente que todos los componentes estén ajustados.

Contenido - Juego de dos piezas **NOTA:** El producto real puede variar de la ilustración.

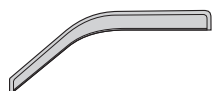

Visera delantera del conductor

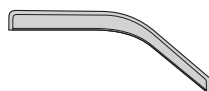

Visera delantera del acompañante



Paño esterilizado x4

Contenido - Juego de cuatro piezas

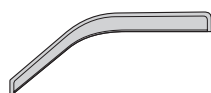

Visera delantera del conductor

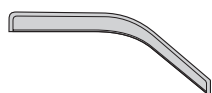

Visera delantera del acompañante



Visera trasera del conductor



Visera trasera del acompañante



Paño esterilizado x4

Herramientas necesarias



Equipo de limpieza de vehículos



Toalla limpia

Preparación antes de pintar o instalar

- Se recomienda realizar un ajuste de prueba para asegurar el posicionamiento y ajuste correctos.
- Compruebe que las piezas se ajusten correctamente antes de pintarlas, ya que no aceptaremos la devolución de piezas modificadas o pintadas.
- Lave los canales de la ventanilla del vehículo para quitar los desechos y la suciedad.
- Seque los canales de la ventanilla con una toalla limpia.

Pasos de instalación

AVISO: La colocación real puede variar levemente con respecto a las ilustraciones.

Alcohol Pad

Limpie la banda de la puerta y la cubierta del espejo donde colocará la visera.

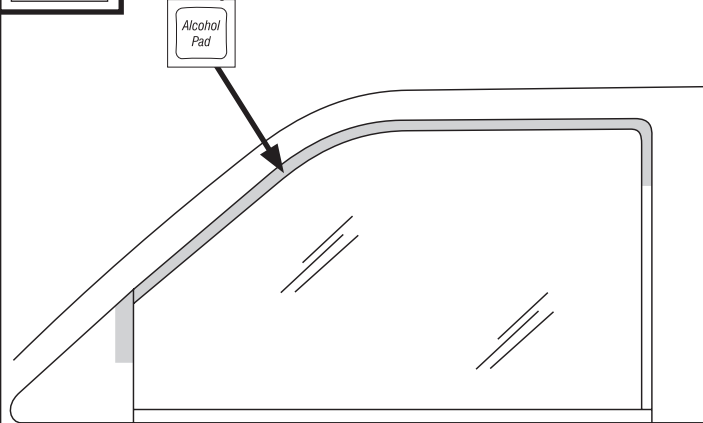

1

Quite la cinta protectora del reborde frontal y trasero. Retire 2 pulgs. de cinta protectora de cada uno de los extremos del reborde superior.

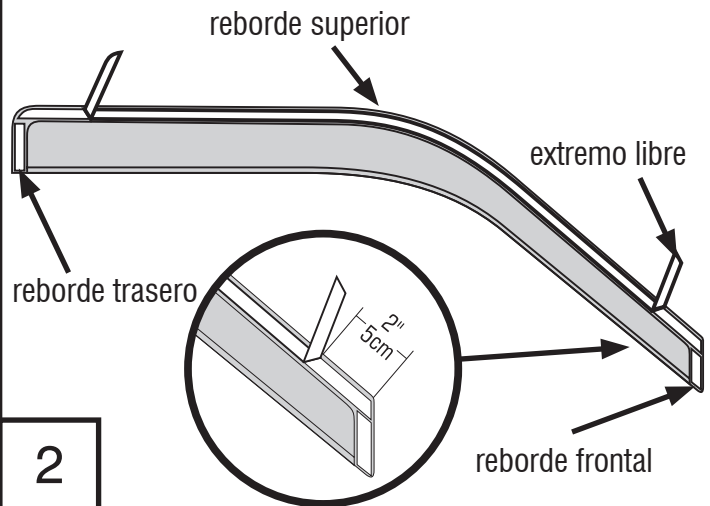

2

Coloque el reborde delantero en la cubierta del espejo. Coloque el rebordo superior y trasero en la banda lateral de la ventanilla. Retire la cinta protectora tirando de los extremos libres.

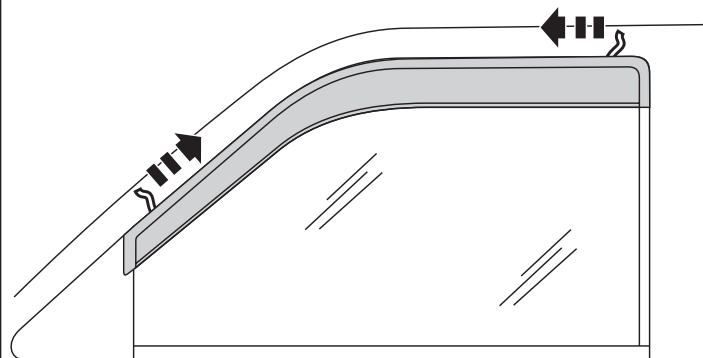

3

Presione en los rebordes de la cinta para fijar.

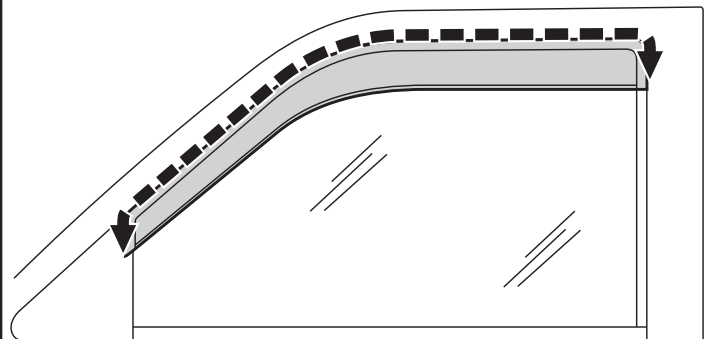

4

Juego de cuatro piezas

La visera trasera se coloca siguiendo los mismos pasos que se siguen para la visera frontal. Coloque la visera en la banda lateral de la ventanilla.

rebordo trasero colocado en la banda lateral

pilar vertical de la ventanilla

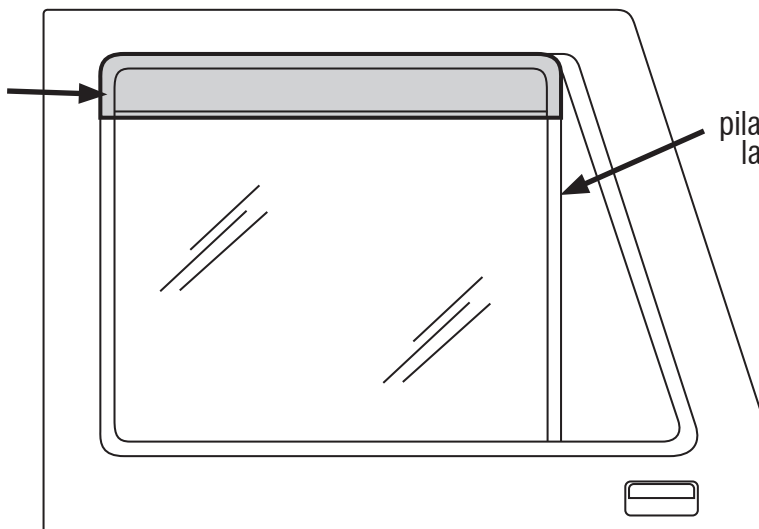

5

Cuidado y limpieza

- Limpie solamente con agua jabonosa tibia y seque con un paño limpio.

Felicidades

Usted ha comprado uno de los tantos artículos de calidad de Auto Ventshade™ ofrecidos por Lund International, Inc. Nuestros productos son nuestro mayor orgullo. Deseamos que disfrute de años de satisfacción con su inversión. Hemos realizado todos los esfuerzos para asegurarnos de que su producto sea de la mejor calidad en cuanto a ajuste, durabilidad, acabado y facilidad de instalación.



AUTO VENTSHADE™

Lund International, Ventshade Accessories Division

655 Raco Drive, Lawrenceville, GA 30045

800-241-7219 • Fax 770-339-5839 • Visite nuestro sitio Web: lundinternational.com



© 2005 Lund International, Inc. Todos los derechos reservados.

Auto Ventshade™, el logo de Auto Ventshade™ y el logo de AVS™ son marcas comerciales de Lund International, Inc.

